

Draft Notes on Communication System

S. Adhikary

The symbolic form of the abbreviated heading for the WMO Message containing a bulletin:

T₁ T₂ A₁ A₂ ii CCCC YYGGgg (BBB)

Where character;

T₁ is taken from WMO Manual 386 table A. It is an alpha character that designates the general code form of the contents of the bulletin (Coded or plain text).

T₂ is taken from WMO Manual 386 tables B1 through B6 depending on the designator T₁ in table A. It is an alpha character that designates the data type.

A₁ is taken from WMO Manual 386 tables C1 through C6 depending on designator T₁. It is an alpha character that designates the geographical area the content of the bulletin covers.

A₂ is taken from WMO Manual 386 tables C1 through C5 depending on designator. It is an alpha character that designates the geographical area, or may define the forecast period.

ii is taken from the WMO Manual 386 from table D1 or D2 depending on designator T₁. It is a numeric set of two characters.

CCCC is the identification of the processing center that generated the bulletin. Commonly centers use alpha character identification designators from ICAO's "Location Indicators Doc 7910/80".

YYGGgg is the day, hour, and minute the bulletin was prepared or the reporting time of the contained reports in it.

(BBB) is an optional group of alpha characters.

appropriate BBB indicator, identified by a three-letter indicator which shall be added after the date-time group.

The BBB indicator shall have the following forms:

RRX for additional or subsequent issuance of bulletins;

CCX for corrections to previously relayed bulletins;

AAX for amendments to previously relayed bulletins;

where x is an alphabetic character starting from A.

OPERATIONAL PROCEDURES APPLICABLE TO THE TRANSMISSION OF METEOROLOGICAL DATA ON THE GLOBAL TELECOMMUNICATION SYSTEM

Format of meteorological messages

A routine meteorological message transmitted on the Global Telecommunication System shall comprise:

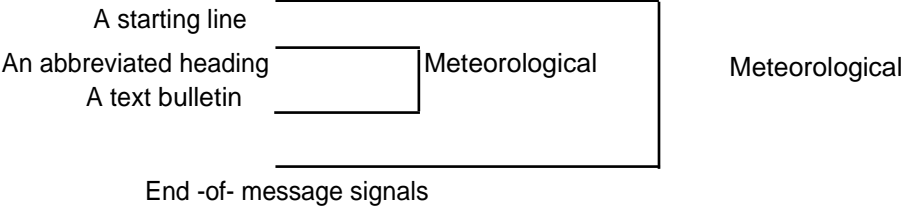

Example:

Starting line

S O H C R C R L F 345

Abbreviated heading

C R C R L F SMIN90 S P VIDP S P 010000

Text

L F AAX X S P 01001
C R C R

C R C R L F 13131 S P S P S P S P S P etc.* ...=

C R C R L F 13272 S P S P S P S P S P etc.* ...=

C R C R L F 13333 S P S P S P S P S P etc.* ...=

C R C R L F 13462 S P S P S P S P S P etc.* ...=

C R C R L F 13586 S P NIL=

End-of-message signals

C R C R L F E T X

*

Legend:

S
O
H

Start of heading (Signal0/1)

C
R

Carriage return (Signal0/13)

L
F

Line feed (Signal 0/10)

S
P

Space (Signal2/0)

E
T
X

End of text (Signal3/13)

= Separator(Signal 3/13)

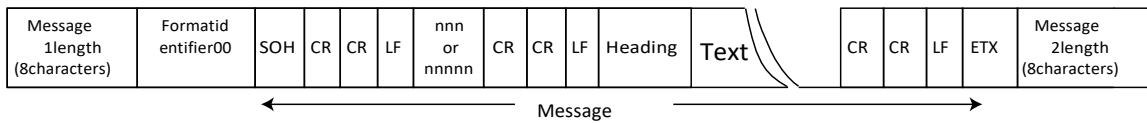

Length Starting
line and end of message present.
Message length :length from SOH to ETX(e.g.00001826=1826bytes)

1. AMSS / RTH

AMSS (Automatic Message Switching System) is the backbone for observational data collection and distribution within India. From observatory data is collected by AMSS High Speed Data Terminal (HSDT), locally developed web portals of AMSS, Email, Telephone etc. AMSS is the sole provider of Indian Meteorological data to Aeronautical Fixed Telecommunications Network (AFTN) for Aviation. There are six AMSS in India namely Delhi, Chennai, Mumbai, Kolkata, Guwahati and Nagpur. These AMSS are connected among themselves as well as Regional Telecommunication Hub (RTH) at New Delhi. RTH New Delhi gets all the meteorological observations/data of whole India through the six AMSS. RTH, New Delhi is also connected to various foreign cities/countries like Tokyo, China, Moscow, Melbourne, Dhaka, Colombo, Tehran, UK, Melbourne etc. through various dedicated as well as Internet links. Indian meteorological data is distributed to these countries as per mutual agreement with WMO. Similarly RTH, New Delhi gets data all over the world through those links. From RTH New Delhi those data is percolated to RMC, MC and other forecasting centres of India through the AMSS. The data flow diagram is given below:

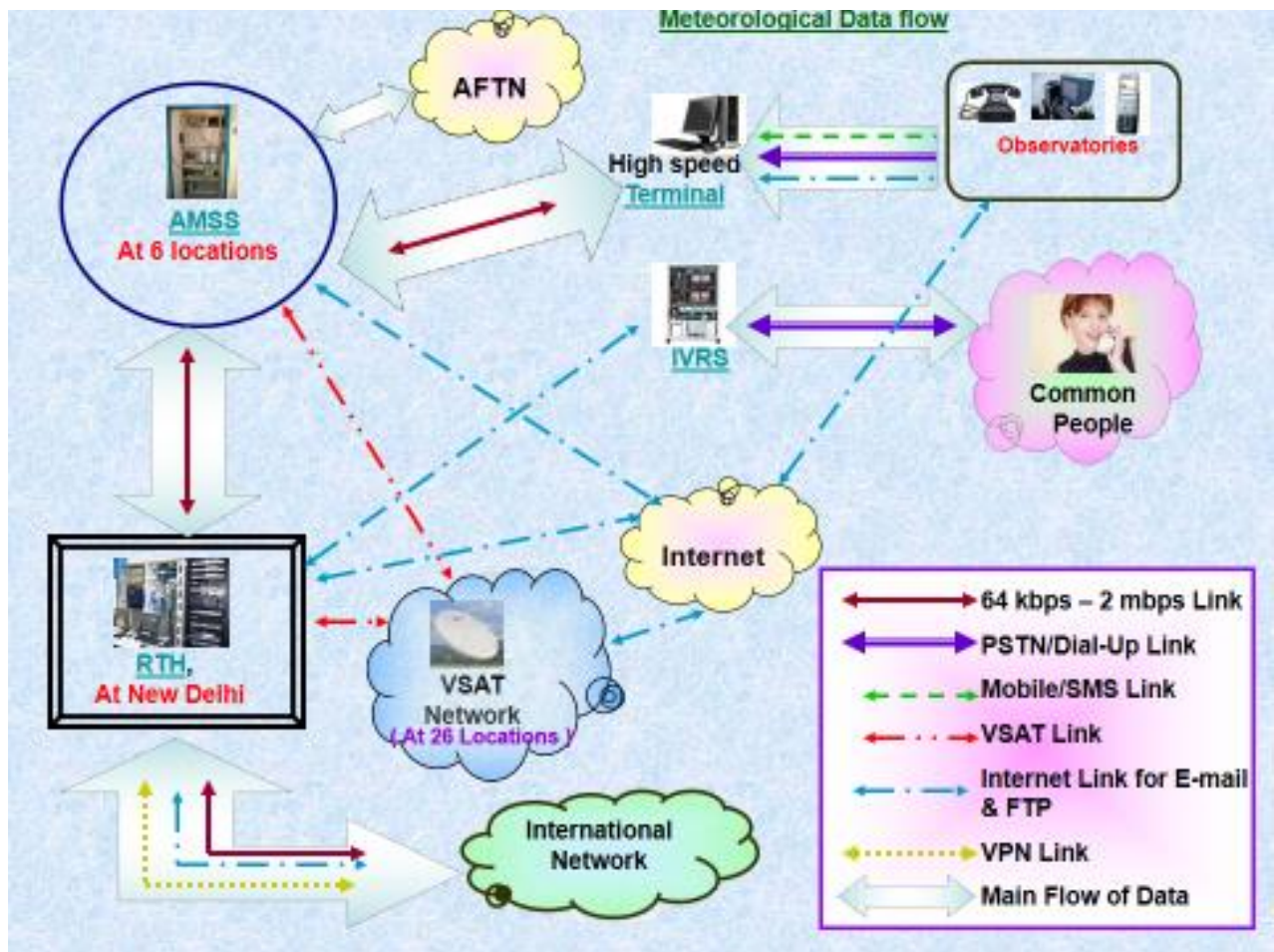

The features of AMSS and RTH are almost same. But AMSS is not connected with any foreign country. Data communication exchange between India and foreign countries is only through RTH, New Delhi.

1.1.1 RTH New Delhi has following functionalities:

RTH, New Delhi is connected to various foreign cities/countries like Tokyo, China, Moscow, Melbourne, Dhaka, Colombo, Tehran, UK, Melbourne etc. through various dedicated as well as Internet links. Indian meteorological data is distributed to these countries as per mutual agreement with WMO. Similarly RTH, New Delhi gets data all over the world through those links. RTH New Delhi is also connected with six AMSS at Delhi, Chennai, Mumbai, Kolkata, Guwahati and Nagpur. From RTH New Delhi those data is percolated to RMC, MC and other forecasting centres of India through data links of RTH New Delhi and the six AMSS at Delhi, Chennai, Mumbai, Kolkata, Guwahati and Nagpur. The features of The RTH, New Delhi are given below:

- Ingest of all data types WMO as well NON-WMO standard such as RADAR, Satellite, Agro meteorological, Hydrological, Seismological and other weather related data etc. received through any mode of communication channels.
- Interpretation, routing and display of GRIdded Binary (GRIB), and Binary Universal Form for the Representation of meteorological data (BUFR) information received via SADIS or on GTS.
- Alphanumeric and binary messages for routine data collection, exchange and distribution.
- Compatibility and conversion of Traditional Alphanumeric Codes (TAC) into WMO Table Driven Code Formats [GRIB1, GRIB2, BUFR, Character form for the Representation and EXchange of meteorological data (CREX)].
- Exchange of imagery, graphics, binary products in WMO Table Driven Code Formats (GRIB, BUFR).
- Generation of BUFR bulletins from ASCII data.
- Conversion of TAC data into BUFR and CREX and vice versa.
- Configuration/modification like WMO/ICAO channels for data streams, sockets, stations, bulletins, bulletin scheduling, various parameters, routing table etc online/offline.
- Sequence number on 3/5 digit checking and automatic request for missing sequences.
- Switching of any type of binary files like Word file, Graphic image, spread sheet or data files for transfer of data fields (pre processed observational data), analysis, forecasts amongst WWW centres.
- Ingest of meteorological data (Alpha numeric, binary, BUFR) through WEB, Email and SMS and transmission support through Email and SMS as the case may be.

- Strict Validation of all data received as per WMO/ICAO provision.
- SADIS data reception, processing and switching.
- Exchange of seismic data, Global Maritime Distress and Safety System (GMDSS) data, and disaster warnings like Tsunami and nuclear accident data (through specific communication interfaces and following specific switching requirements and handling different formats).
- Provision of storing the operational data for a period of 24 hrs.
- System has user friendly GUI Tool for day to day monitoring of data RX/TX, system efficiency, circuits status, remote node status etc besides GTS operations of WMO.

1.1.2 The present AMSS Systems have following functionalities:

AMSS (Automatic Message Switching System) is the backbone for observational data collection and distribution within India. From observatory data is collected by AMSS High Speed Data Terminal (HSDT), locally developed web portals of AMSS, Email, Telephone etc. AMSS is the sole provider of Indian Meteorological data to Aeronautical Fixed Telecommunications Network (AFTN) for Aviation. There are six AMSS in India namely Delhi, Chennai, Mumbai, Kolkata, Guwahati and Nagpur. These AMSS are connected among themselves as well as Regional Telecommunication Hub (RTH) at New Delhi. RTH New Delhi gets all the meteorological observations/data of whole India through the six AMSS. Similarly these AMSS receive all the required data throughout the globe from RTH New Delhi. The features of AMSS are given below:

- Ingest of all data types WMO as well NON-WMO standard such as RADAR, Satellite, Agro meteorological, Hydrological, Seismological and other weather related data etc. received through any mode of communication channels.
- Interpretation, routing and display of GRIBed Binary (GRIB), and Binary Universal Form for the Representation of meteorological data (BUFR) information received via SADIS or on GTS.
- Alphanumeric and binary messages for routine data collection, exchange and distribution.
- Compatibility and conversion of Traditional Alphanumeric Codes (TAC) into WMO Table Driven Code Formats [GRIB1, GRIB2, BUFR, Character form for the Representation and EXchange of meteorological data (CREX)].
- Exchange of imagery, graphics, binary products in WMO Table Driven Code Formats (GRIB, BUFR).
- Generation of BUFR bulletins from ASCII data.
- Conversion of TAC data into BUFR and CREX and vice versa.

- Configuration/modification like WMO/ICAO channels for data streams, sockets, stations, bulletins, bulletin scheduling, various parameters, routing table etc online/offline.
- Sequence number on 3/5 digit checking and automatic request for missing sequences.
- Switching of any type of binary files like Word file, Graphic image, spread sheet or data files for transfer of data fields (pre processed observational data), analysis, forecasts amongst WWW centres.
- Ingest of meteorological data (Alpha numeric, binary, BUFR) through WEB, Email and SMS and transmission support through Email and SMS as the case may be.
- Strict Validation of all data received as per WMO/ICAO provision.
- SADIS data reception, processing and switching.
- Exchange of seismic data, Global Maritime Distress and Safety System (GMDSS) data, and disaster warnings like Tsunami and nuclear accident data (through specific communication interfaces and following specific switching requirements and handling different formats).
- Provision of storing the operational data for a period of 24 hrs.
- System has user friendly GUI Tool for day to day monitoring of data RX/TX, system efficiency, circuits status, remote node status etc besides GTS operations of WMO.

1.2 Monitoring of messages:

One of the main purpose of RTH as well as AMSS system is to monitor various types of messages for their timely reception. If any message is not received, then it is the duty of the Duty Officer/staff to contact the respective user responsible for data transmission for immediate transmission of data. If the existing link for data transmission is unserviceable, then alternate arrangement is to be made for immediate collection of data. Data can be monitored using various parameters like TTAAii, CCCC, station code, date and time (DDYYgg) etc. Another important aspect of this monitoring tool is the detection of messages with wrong message format. If there is any message with wrong format, then the message is sent by the system in a error queue and highlighted prominently and the message is prevented from transmission. Once the message is corrected by the on duty staff, the corrected message is transmitted.

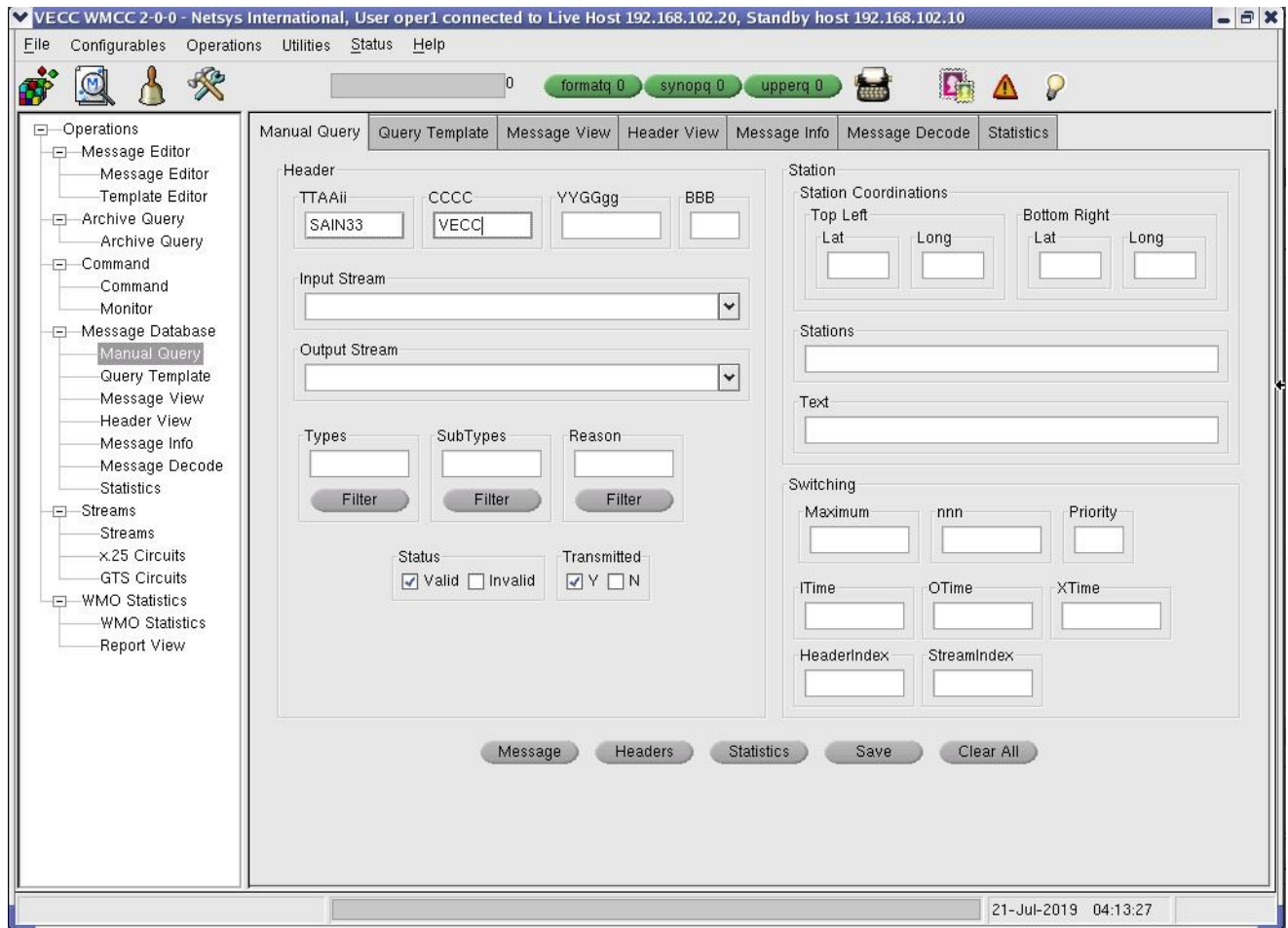

Message monitoring GUI

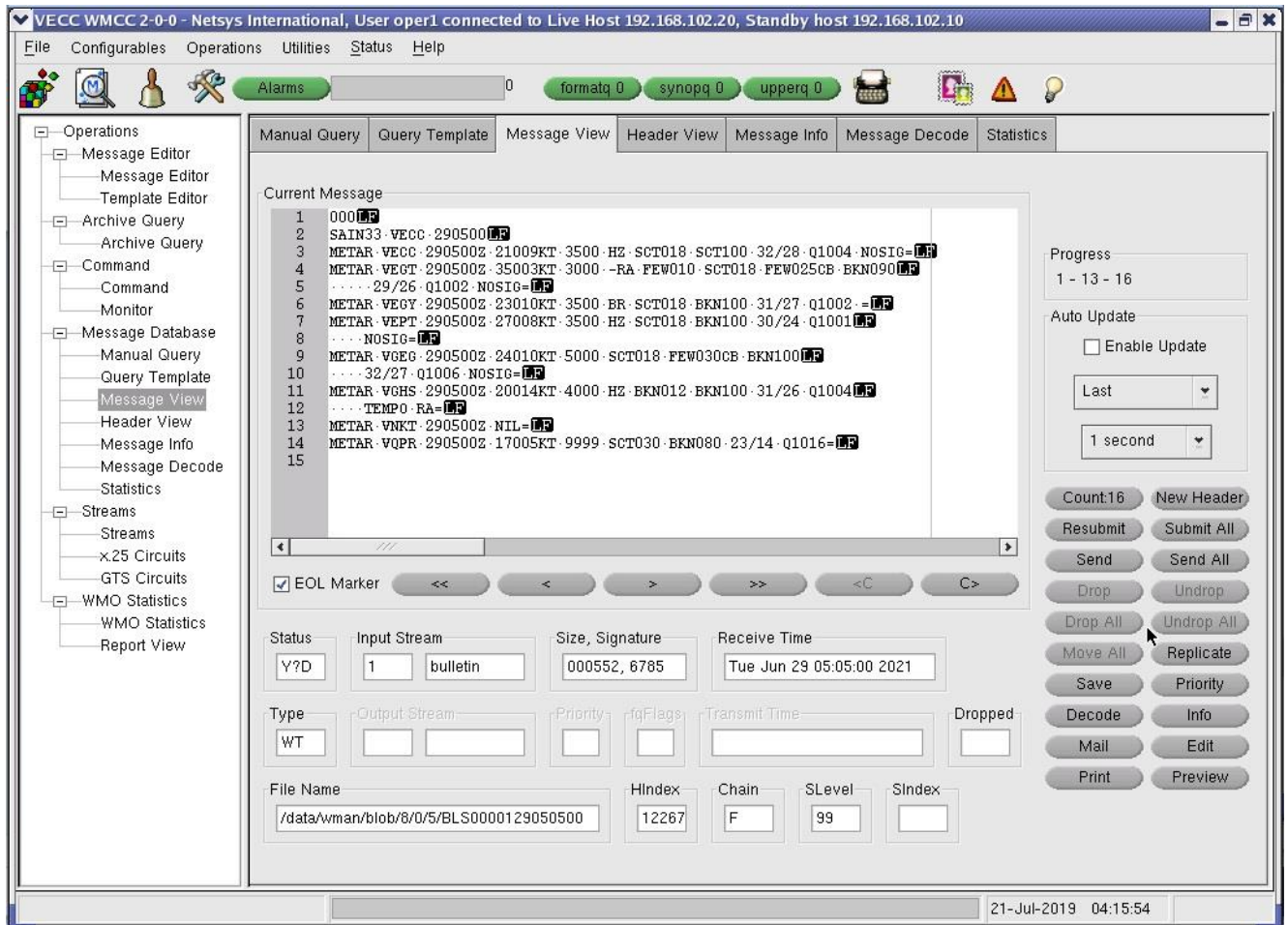

Retrieved message

1.3 RTH/AMSS Scheduler:

In RTH as well as AMSS, scheduler is a very important modules of the system. This scheduler is used to transmit a message with a particular header at a predefined time. The scheduler can perform repetitive task at predefined times of every hour, at predefined times of a day, at a predefined time in a month etc. Often this scheduler is associated with Bulletin generation and transmission of bulletin at predefined time using the help of scheduler.

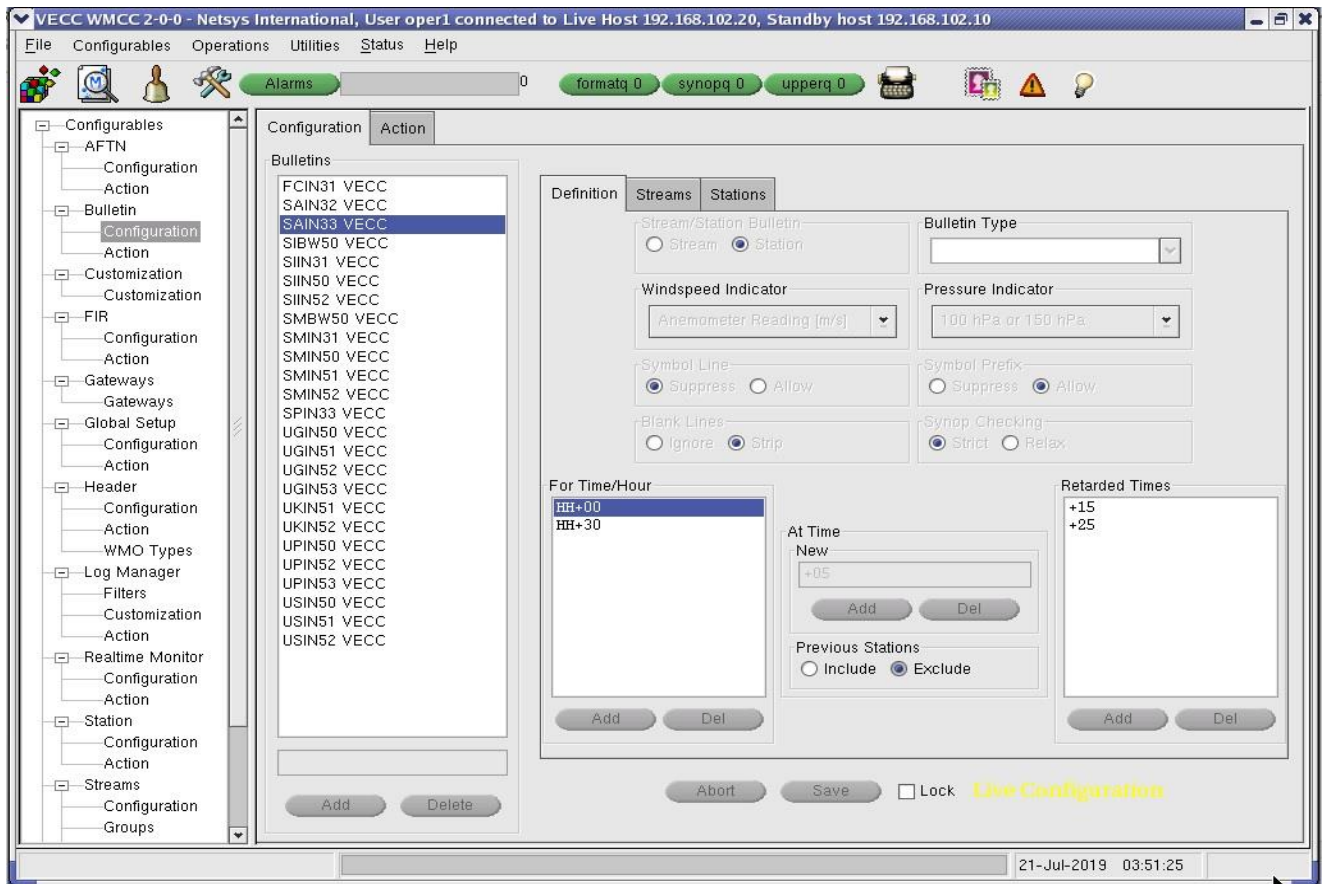

1.4 Data transmission channel for AMSS/RTH:

In RTH as well as AMSS, there is GUI to configure data channel. By configuring this channel, we define what types of messages will be transmitted to a particular station. There is configuration for both incoming as well as outgoing messages. The configuration of outgoing and incoming messages is through Message headers. Here outgoing and incoming message header are configured. In this configuration wild cards are used to configure group of messages using one wild card header. There is also configuration for types of protocol to be used for data communication i.e. socket, FTP, Email etc. along with destination Server IP, Email etc.

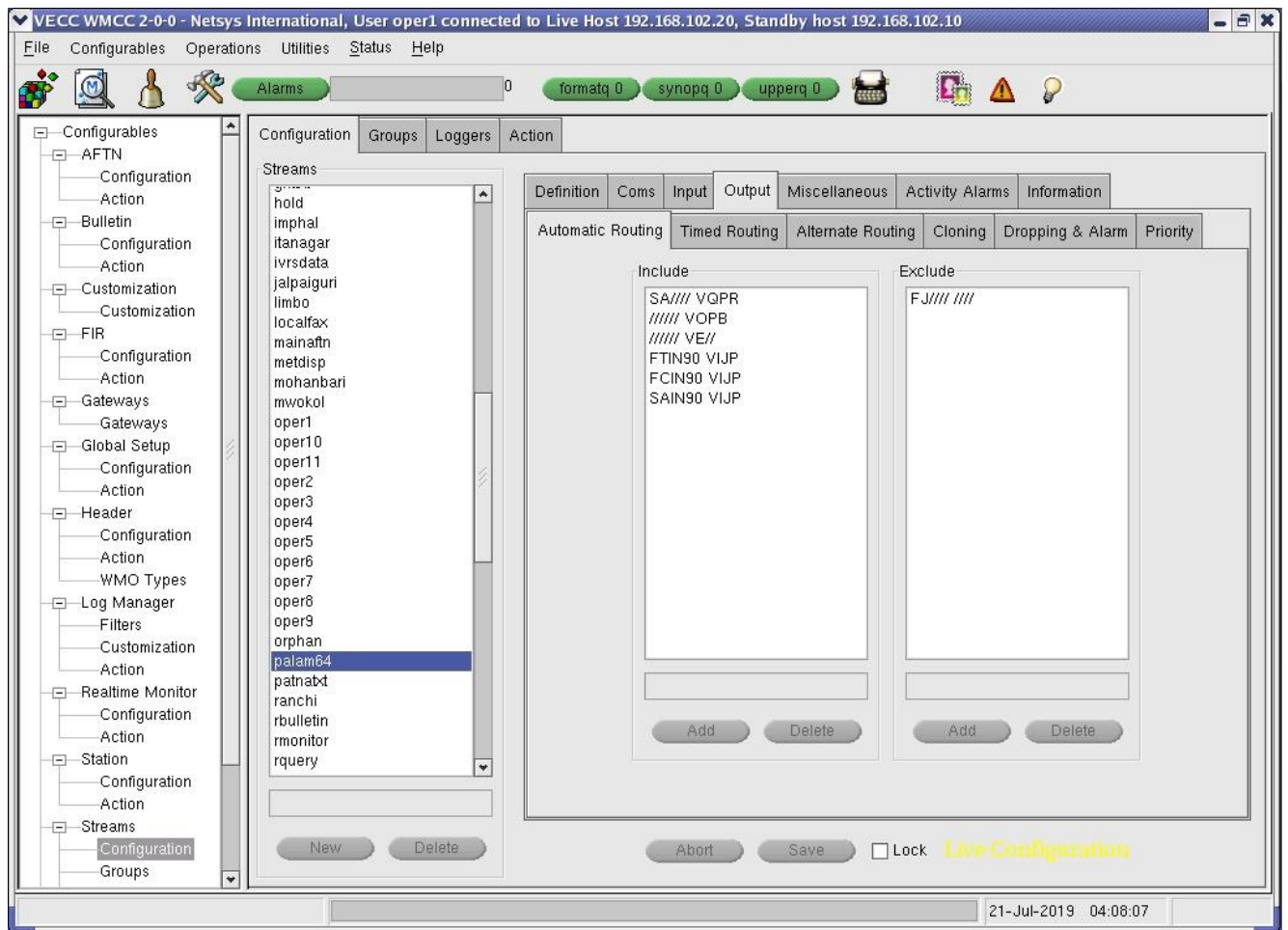

Channel configuration: Output

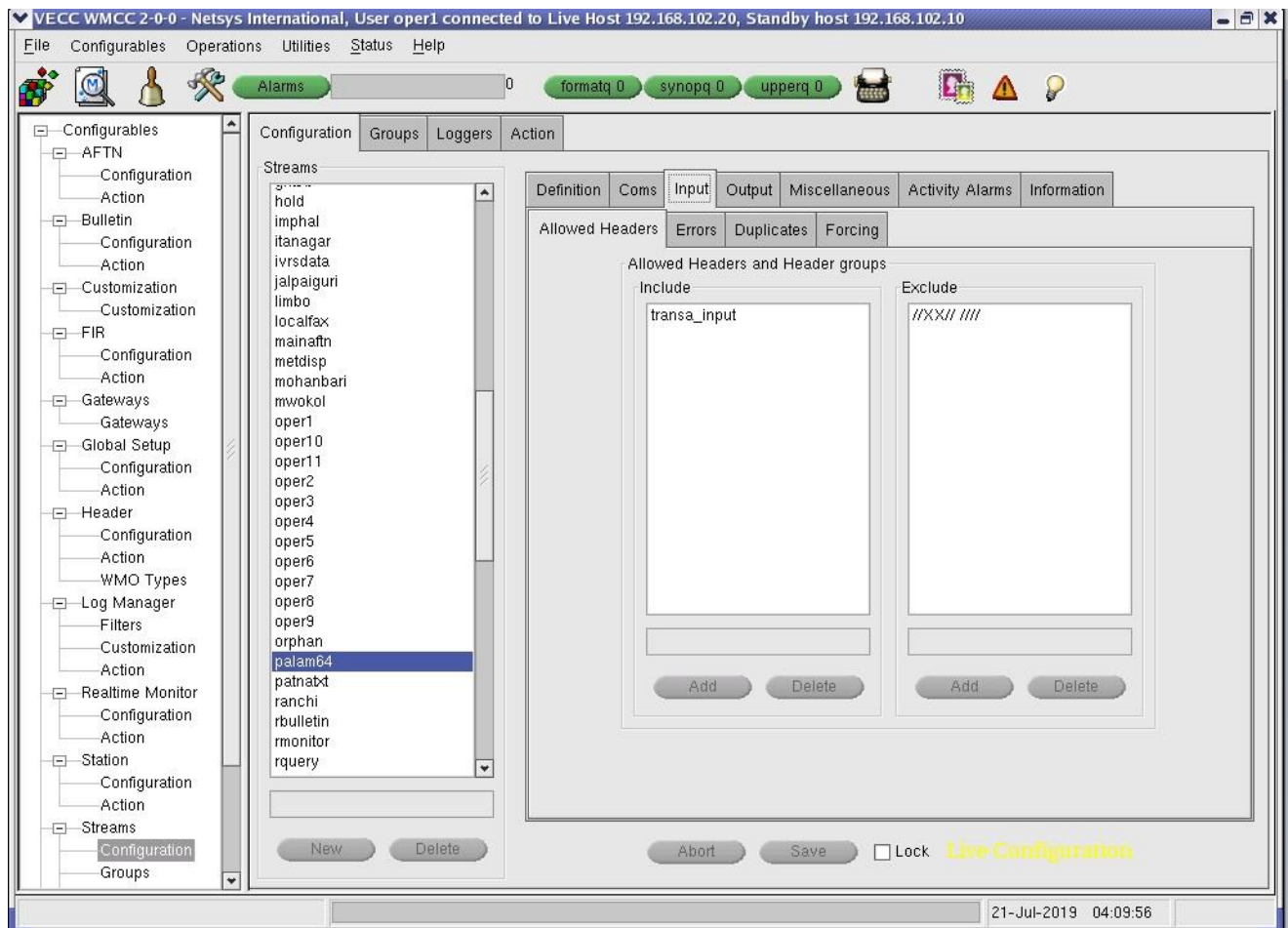

Channel configuration: Input

1.5 ROUTING CATALOGUES

FORMAT OF THE ROUTING CATALOGUE

The routing catalogue should be produced as an ASCII file, which could be imported into database applications. The information should therefore be presented in a database structure. The hereunder structure allows an easy display on a screen, e.g. using a “view” command.

The file containing the routing catalogue of a GTS centre should be named: CCCCROCA.TXT, where CCCC is the location indicator of the centre. The date of the preparation of the catalogue should be inserted in the first line of the line as YYYYMMDD (where YYYY is the year, MM the month and DD the day).

For each abbreviated heading, a records should comprise the following fields

<i>Field number</i>	<i>Content</i>	<i>Width</i>
1	Abbreviated heading TTAAii CCCC	11
2	GTS circuit from which the bulletin is received (see paragraph 1.4)	4
3	GTS circuit to which the bulletin is sent (see paragraph 1.4)	4
As many additional fields in the format of field No. 3 as additional circuits to which the bulletin is sent.		

The following combination of four characters should be used to designate the GTS circuits and entered into fields No. 2, 3 and subsequent fields:
 In the combination of characters CCCC, wild cards "*" should only be used when the GTS centre cannot provide complete information. The use of wild cards is not recommended, since it limits the information.

The fields should be surrounded by quotes and separated by commas.

Sample of structure:

"SMAA01 EGRR", "RJTD", "ANOU", "DEMS", "NFFN", "NTAA", "NZKL", "PMBY"
 "SMAA01 EGRR", "KWBC", "NZKL"
 "SMAA10 KWBC", "EGRR", "DEMS", "NFFN", "NTAA", "NZKL", "WIIX"

2. SADIS

A BRIEF DESCRIPTION OF SADIS

SADIS 2G is an operational system dedicated primarily to aeronautical meteorological information in line with ICAO worldwide provisions. WAFS forecasts and OPMET information is disseminated without conflict or delay which could be caused by the dissemination of non-operational data. This ensures full availability of the service and the largely error-free transmission of all information required for pre-flight planning. WAFS GRIB and BUFR forecasts are backed up, with WAFS London and WAFS Washington products being interchangeable.

SADIS 2G provides a point to multi-point service on a 24-hour basis via satellite. The SADIS 2G uplink is situated at the Cable & Wireless hub at Whitehill Earth Station,

north of Oxford in the United Kingdom. WAFS forecasts are provided from WAFC London at the United Kingdom Met Office (referred to as “Met Office”), Exeter, and are uplinked from the hub at Whitehill to the INTELSAT satellite located over the Indian Ocean at 60°E. OPMET information is provided by the National Air Traffic Services (NATS) SADIS Gateway facility at Swanwick near Southampton, United Kingdom. Data from the SADIS Gateway is transmitted to the Met Office for onward promulgation to Whitehill. The data are downlinked via a global beam to users anywhere in the EUR, AFI and MID Regions and in the ASIA Region as far eastwards as 140°E.

SADIS 2G delivers WAFS forecasts in digital format, as well as alphanumeric OPMET information required for pre-flight planning.

In addition to the SADIS 2G satellite service, approved SADIS users can access all OPMET information and WAFS forecasts using FTP over the public Internet via the Secure SADIS FTP service.

3. Aeronautical Fixed Telecom Network (AFTN)

AFTN (Aeronautical Fixed Telecom Network) is the dedicated telecommunication network used for exchange of aeronautical messages and data between different aeronautical stations. It is also the primary channel for exchange of Operational Met Messages (OPMET) between different Aerodrome Met Offices and Aeronautical Met Stations. The technology used for transmission and reception in AFTN is based on the Telex protocols and is limited to text only messages with a maximum length of 1800 characters.

The IMD departmental telecommunication network is linked to AFTN through six AMSS centers located at Delhi, Kolkata, Mumbai, Chennai, Nagpur and Guwahati. Each destination under the AFTN is identified by a unique code.

Facility code	refers to
YNYX	"NOTAM Office"
YZYX	"Met Data Bank"
YMYX	"Local Met Office"

YFYX	"AFTN Office"
ZTZX	"Control tower"
ZPZX	"ATS Reporting Office"
ZQZX	"Area Control Center"

As per the above addressing system, The AFTN address VIDPYMYX will refer to Met Office of Delhi (Palam) airport and VOMMZTZX will refer to Control Tower Chennai airport.

Priority indicators:

All the messages exchanged over AFTN carry any of the following priority indicators

- a. Priority Indicator **SS** for Distress Messages
- b. Priority Indicator **DD** for Urgency Messages
- c. Priority Indicator **FF** for Flight Safety Messages, SIGMET Messages.
- d. Priority Indicator **GG** for Meteorological Messages, Flight Regularity Messages and Aeronautical Information Services Messages.

OPMET bulletins transmitted via AFTN should use the following priority indicators:

SIGMET, AIREP SPECIAL (special air-reports), VAA, TCA – PRIORITY - FF

TAF, METAR and SPECI – PRIORITY – GG

Example of an AFTN message:

```

IMD2236 130505<
GG OPZZYPYX RJAAYPYX RJTDYPYX RJTDYZYX VABBYPYX VCCYPYX
VECCYJYX<
VECCYPYX VGEGYPYX VGHSYPYX VHZZYPYX VIDPCTFM VIDPYPYX
VNKTYPYX<
VTBBYPYX VTBBYZYX WSSSYZYX WSZZYPYM YBBYPYX YBZZSPWX<
281305 VECCYMYX<
SAIN33 VECC 281300<
METAR VECC 281300Z 20010KT 3600 HZ SCT018 SCT100 31/27 Q1003 NOSIG=<
METAR VEGT 281300Z 00000KT 4000 BR SCT018 BKN100 30/26 Q1001 NOSIG=<
METAR VEGY 281300Z 00000KT 3000 HZ SCT020 BKN100 33/27 Q1001 =<
METAR VEPT 281300Z 00000KT 3500 HZ SCT018 BKN100 30/24 Q1000<
BECMG 3000 HZ=<
METAR VGEG 281300Z NIL=<
METAR VGHS 281300Z 18014KT 4000 HZ SCT012 BKN100 32/25 Q1004 NOSIG=<

```

METAR VNKT 281300Z NIL=<
METAR VQPR 281300Z 15011KT 8000 SCT020 OVC060 23/13 Q1015=<

In the above message:

Sequence number is 2236,

Transmit Time is 130505.

Priority is GG,

Transmit Date and time: 281305

Originating Station: VECCYMYX

Destination addresses: OPZZYPYX RJAAYPYX RJTDYPYX RJTDYZYX VABBYPYX

VCCYPYX VECCYJYX VECCYPYX VGEGYPYX VGHSYPYX VHZZYPYX

VIDPCTFM VIDPYPYX VNKTYPYX

VTBBYPYX VTBBYZYX WSSSYZYX WSZZYPYM YBBBYPYX YBZZSPWX

Message header: SAIN33 VECC 281300

Messages:

METAR VECC 281300Z 20010KT 3600 HZ SCT018 SCT100 31/27 Q1003 NOSIG=<

METAR VEGT 281300Z 00000KT 4000 BR SCT018 BKN100 30/26 Q1001 NOSIG=<

METAR VEGY 281300Z 00000KT 3000 HZ SCT020 BKN100 33/27 Q1001 =<

METAR VEPT 281300Z 00000KT 3500 HZ SCT018 BKN100 30/24 Q1000<

BECMG 3000 HZ=<

METAR VGEG 281300Z NIL=<

METAR VGHS 281300Z 18014KT 4000 HZ SCT012 BKN100 32/25 Q1004 NOSIG=<

METAR VNKT 281300Z NIL=<

METAR VQPR 281300Z 15011KT 8000 SCT020 OVC060 23/13 Q1015=<

4. Central Information and Processing System (CIPS)

A step towards modernization of India Meteorological Department (IMD), Central Information and Processing System (CIPS) gives a paradigm shift in IMD's core activities towards *integrated and connected Information Systems* to provide effective services to the user community. CIPS, equipped with latest state-of-the art technology is able to handle, manage, store, process and archive all data and products used operationally within IMD. It consists of 7 sub-systems comprising of Data acquisition, Data policy management, National Data Centre, Task Policy Management, Tasks Centre, Backup Policy **Management** and Backup. Working based on Linux Operating System, CIPS Data centre along with CIPS Access Layer provide flexibility to ingest, manipulate, storage and retrieval all types of operational data whereas CIPS Task .Centre incorporates a large number of state of the art development tools with variety of compilers gives a user desired tasks development & multidisciplinary research activities PLATFORM and execute, run, manage the developed tasks automatically. Complying with the WIS policy, CIPS provide a web interface called SIMDAT to authorized Users to view and download the meteorological data available in

its databases. **ZABBIX** and **NetVault** are the monitoring and backup(security) tools of CIPS. Introduction of CIPS is benefitting the department by storing operational observations, Satellite, Radar & NWP model data at single platform.

CIPS at Glance

Operating System: Linux CentOS

Database Software: Oracle 10g

System Hardware: Total 14 servers and 14 client machines used for handling and monitoring the CIPS system.

CIPS SAN Storage

Operational Data Storage : 07TB (4 Array x12 Disk x146 GB)

Archive Data Storage : 24 TB (5 Array x 12 Disk x 400 GB)

Operational Data storage uses RAID 1 giving 4 TB of usable space while Archive Data Storage uses RAID 5 giving 13 TB of usable space.

5. SYNERGIE -A WEATHER FORECASTING TOOL

System Operating System- LnuX CentOS

System Hardware: Two Servers one Operational and one standby and at least 2 Client machines with at least 3 display with each client machine.

Synergie: Synergie is a new forecasting application software suites added into IMD under IMD modernization scheme for improvement in weather forecasting. The synergie weather forecasting tool is the product of Meteo France International (MFI), a French company located in TOULOUS, FRANCE. It is basically a Graphical User Interface(GUI) Tool to display and manipulate all sorts of operational weather data like observation, NWP Models, Satellite and DWR weather Radar by a good and experience weather forecaster for concluding the best possible correct weather forecast for public and aviation.

Synergie system has been installed and working at **HQ New Delhi, All RMC's, DDGM(WF) Pune, RMTC Pune, MC Bhubneshwar, MC Srinagar, MO Kolkata, MO Palam and NCMRWF Noida.**

The main screen of Synergie forecasting tool depicted buttons of different graphical features as given below:

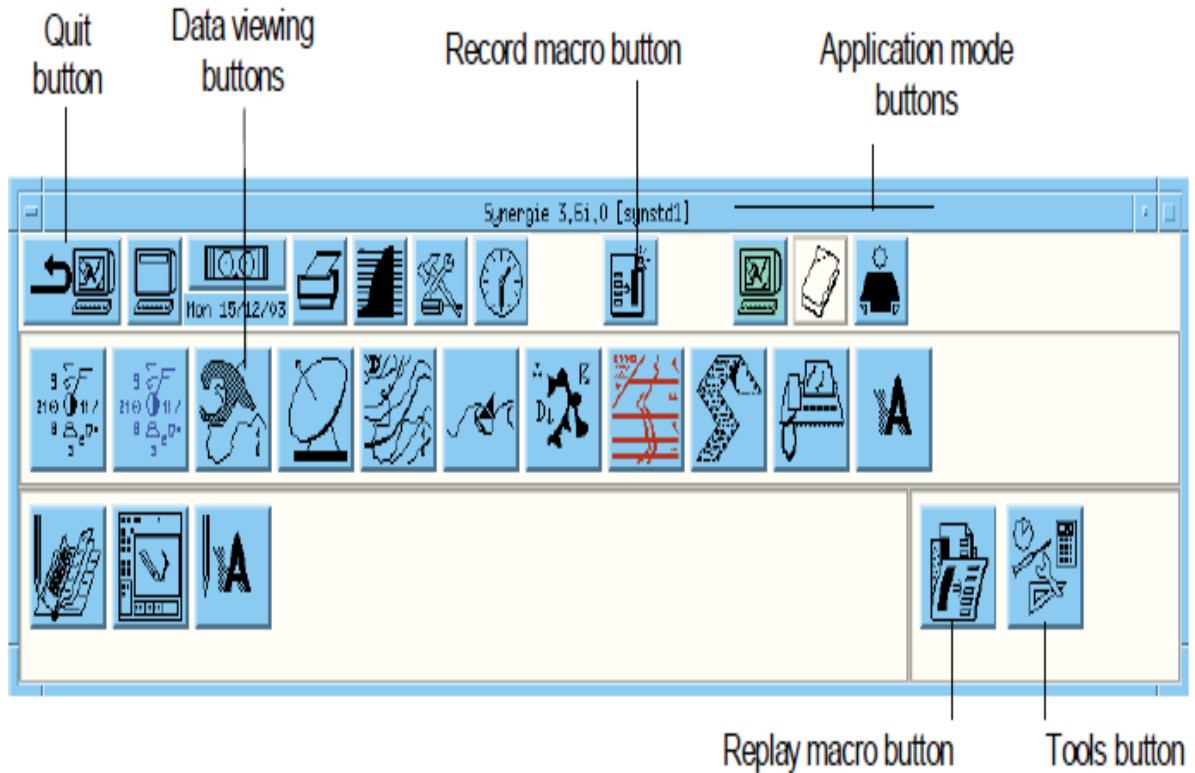

Fig : Synergie Main Menu Window

6. WMO Information System (WIS)

The WMO Information System (WIS) is a project designed to enhance WMO's existing Global Telecommunication System (GTS) and to establish a common Information and Communications Technology (ICT) infrastructure for all WMO programmes and related international initiatives.

DAR and GTS

WIS consists of two parallel parts: GTS and DAR (Discovery, Access and Retrieval). WMO continues its efforts to enhance and improve of GTS, while new DAR functionality is integrated into all WMO and related international programmes.

GTS has long served as the backbone of World Weather Watch Programme (WWWP) — a push-based distribution system for operationally critical data. In response to the growth of the

computer industry and the rise of the Internet, which have enabled the use of meteorological information online in a variety of non-operational and interdisciplinary activities, WIS was conceived as a project to fill existing gaps and support the inter-community exchange of data and information.

At the center of DAR is a catalogue of the entire WIS. GISCs collect all metadata from WIS Centres in their areas of responsibility, and exchange metadata sets with one another.

Organization of WIS

WIS consists of three types of centers:

GISCs (Global Information System Centres)

GISCs (Global Information System Centres) are responsible for:

- Management of AMDCN (the Area Meteorological Data Communication Network)
- Services relating to data intended for global distribution (known as a GISC Cache)
- Cataloguing of the entire WIS

DCPCs (Data Collection or Production Centres)

DCPCs (Data Collection or Production Centres) are designated for each WMO programme activity. They typically engage in:

- Production of specialized information (e.g., for RSMCs)
- Collection and archiving of information in a domain (e.g., for WMO WDCs (World Data Centre))
- Telecommunication hub activities (e.g., for GTS RTHs)

NCs (National Centres)

NCs (National Centres) can be established in each WMO member state. They are responsible for collecting national observation data and submitting them to the WIS network. NCs are also responsible for domestic data distribution networks.

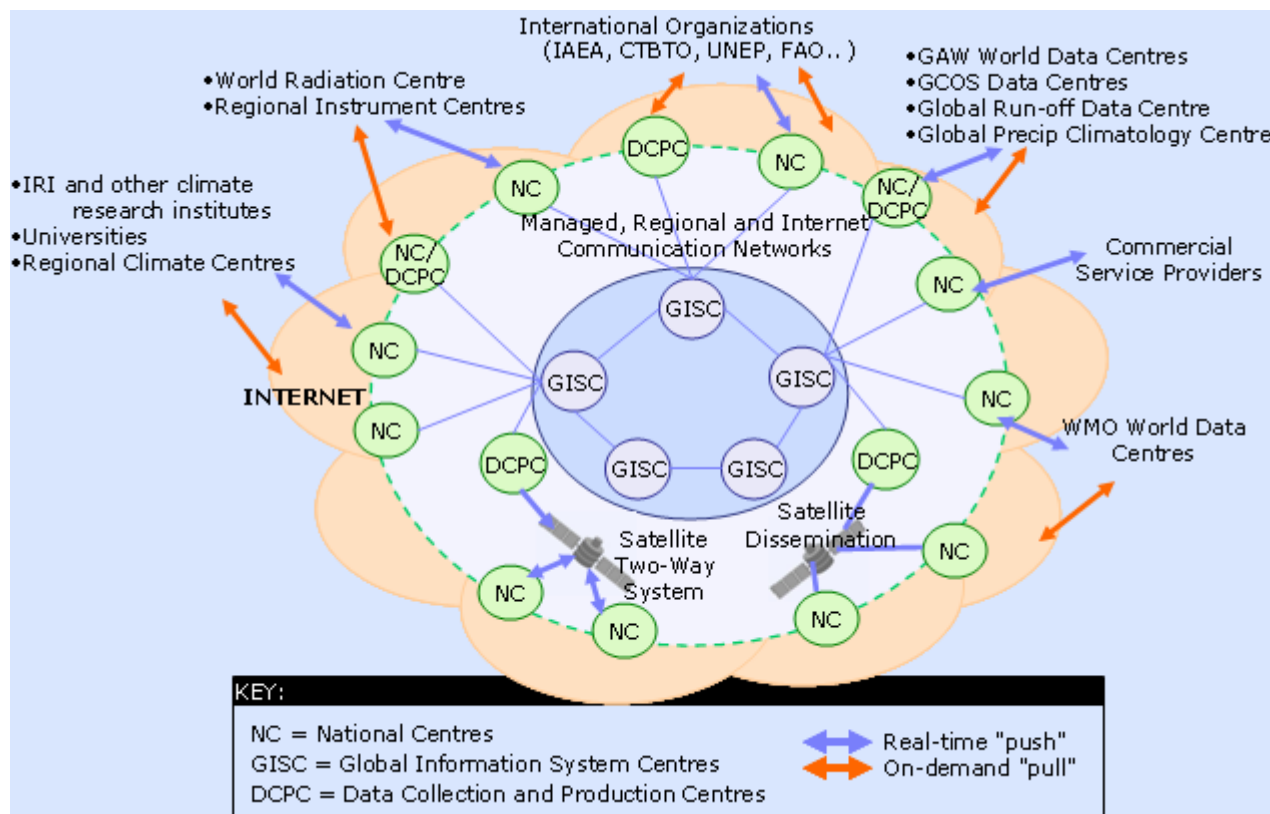

Global Information System Centres

[Global Information System Centres](#) (GISCs) are operated by WMO Members as a major component of the WMO Information System (WIS) infrastructure. A GISC's primary role is to collect from and disseminate information to [WIS centres](#) in its area of responsibility and with the global WMO community. GISCs also provide search portals through which information from WMO and other interoperable systems can be discovered and accessed.

Each WIS centre is associated with a principal GISC that serves as the centre's main entry point for distributing and receiving WIS data and metadata by appropriate telecommunication systems, including the GTS. Association between a centre and a GISC is established by bilateral agreement.

The [WIS centres database](#) contains a list of WIS centres and their associated principal and back-up GISCs.

WIS discovery metadata is the basis of the information and data management of WIS and WIS centres manage their metadata through their principal GISC.

WIS centres can either download their start-up metadata from any operational GISC, edit it locally and then make it available to their principal GISC, or manage the metadata directly through their principal GISC.

7. Online Met Briefing System (OLBS)

Online Met Briefing System (OLBS) provides weather information to pilots, dispatchers and air traffic controllers to support flight safety and efficiency. It provides a crucial service to the national and international civil aviation sector in fulfilment of the requirements prescribed by the International Civil Aviation Organisation (ICAO) and the Director General of Civil Aviation of India (DGCA).

OLBS Server is a combination of a Message Handler and a Web Server. It is connected to the AMSS/RTH communication server and handles messages. Hence it receives global aviation data and products through AMSS/RTH. The web-server provides web pages for online Met Briefing as well as data input pages to input Take Off data, Local Weather Forecast, Warnings etc., by other Met Offices. All products are either automatically uploaded on receipt from AMSS/RTH or product generator upload using web-pages.

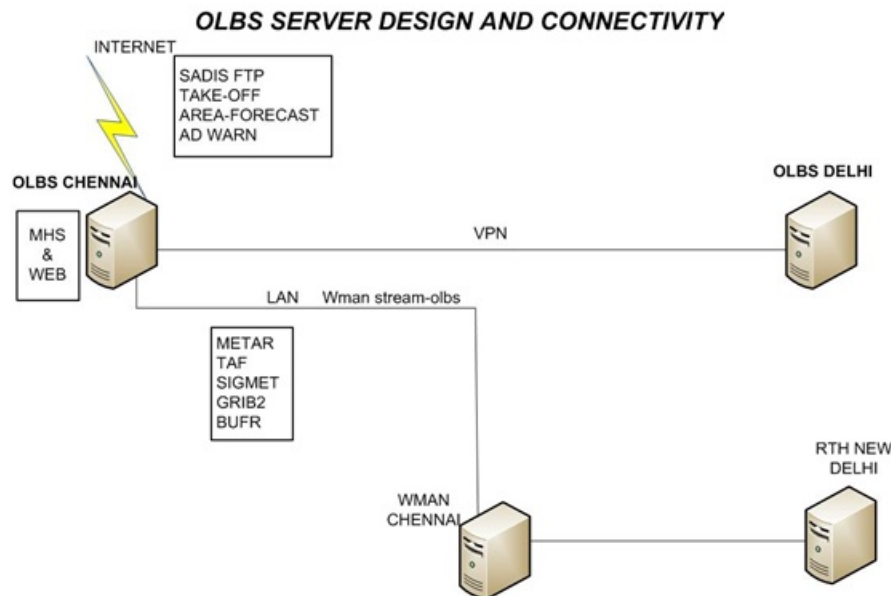

The products uploaded in OLBS can be classified as 1. Scheduled products, which are to be uploaded and made available always and 2. Non-scheduled products are uploaded as and when the products are generated by the issuing offices. All timings are in UTC.

1. Scheduled Products: These products are uploaded at fixed timings as per the observation schedule or issue schedule.

- i. METAR,
- ii. Take-off Data,
- iii. TAF,
- iv. Area Forecast,
- v. WAFC Wind/Temp,

- vi. IMD Wind Temp Charts,
 - vii. WAFC SigWx Charts,
 - viii. IMD SigWx Charts,
 - ix. Radar Pictures,
 - x. SAT images,
 - xi. All India Weather Forecast Bulletin,
 - xii. Regional and all India Inferences.
- Availability of these products are monitored at regular intervals.

OLBS Product Schedules:

-METAR:

Originator: AMS and AMOs

Time of observation: HH+00, HH+30

It is required to transmit METAR within 05 minutes of observation. After transmission, the data is automatically received by OLBS through the communication network of IMD and AFTN.

Short TAF Schedule:

Validity	Issue Time/Upload Time
00-09	2300
03-12	0200
06-15	0500
09-18	0800
12-21	1100
15-24	1400
18-03	1700
21-06	2000

Long TAF Schedule:

Validity	Issue Time/Upload Time
00-06	2300
06-12	0500
12-18	1100
18-24	1700

Take-Off Data Schedule:

Validity	Issue Time/Upload Time
0100-0600	0030
0400-0900	0330
0700-1200	0630
1000-1500	0930
1300-1800	1230
1600-2100	1530
1900-2400	1830
2200-0300	2130

Area forecast Schedule:

Validity	Issue Time/Upload Time
0600-1400	0530
1400-2200	1330
2200-0600	2130

WAFC GRIB2 Generation Schedule:

Data time	Generation Time/Upload Time
0000	0430
0600	1030
1200	1630
1800	2230

WAFC SIGWX CHART Generation Schedule:

Data time	Chart Generation Time/Upload Time
0000	0910
0600	1510
1200	2110
1800	0310

IMD W/T Carts Schedule:

Validity	Upload Time
----------	-------------

Data time 0000	0712
Data time 0600	1312
Data time 1200	1912
Data time 1800	0112

- Radar Pictures:

Originator: DWR Stations

Time Of Issue: Every 10 minutes

Mode of collection and upload: FTP

- SAT Images:

Originator: SAT Met, New Delhi

Time of Issue: Every 30 Mts

Mode of collection: FTP

- IWB:

Originator: IMD, Pune

Time of Issue: Based on 0300UTC and 1200UTC

Mode of collection and upload: AMSS through RTH New Delhi

2. Non-Scheduled Products:

These products are generated by Offices whenever certain weather phenomena occur in the area concerned. They are i. Aerodrome Warning, ii. SIGMET iii. Tropical Cyclone Advisories.

i. Aerodrome Warning:

Originator: AMO

Mode of collection and upload: OLBS WEB form

ii. SIGMET:

Originator: MWO

Mode of collection and upload: AMSS

iii. Tropical Cyclone Advisories:

Originator: TCAC, New Delhi

Mode of collection and upload: Received through Email and uploaded using Graphical Tropical Cyclone Advisory

8. VSAT

A Very Small Aperture Terminal (VSAT), is a two-way satellite ground station . The majority of VSAT antennas range from 75 cm to 1.2 m. Data rates typically range from 56 Kbit/s up to 4 Mbit/s. VSATs access satellites in geosynchronous orbit to relay data from small remote earth stations (terminals) to other terminals (in mesh configurations) or master earth station "hubs" (in star configurations).

VSATs are most commonly used to transmit narrowband data (point of sale transactions such as credit card, polling or Supervisory Control and Data Acquisition (SCADA) or broadband data (for the provision of Satellite Internet access to remote locations, VoIP or video). VSATs are also used for transportable, on-the- move (utilising phased array antennas) or mobile maritime communications.

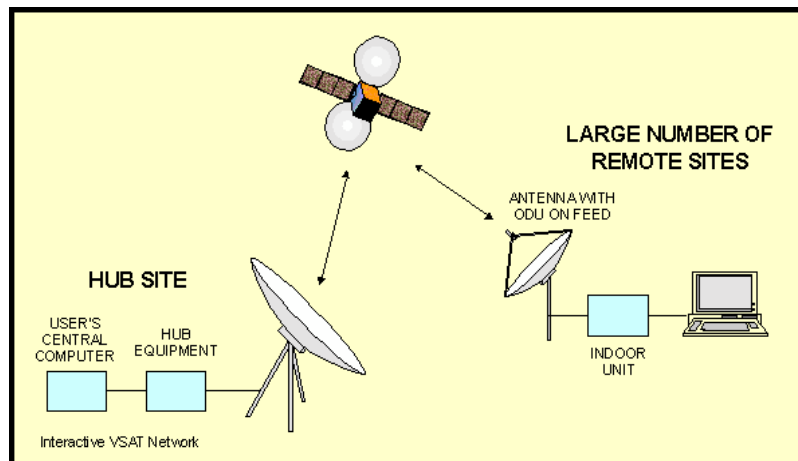

VSAT Systems in IMD

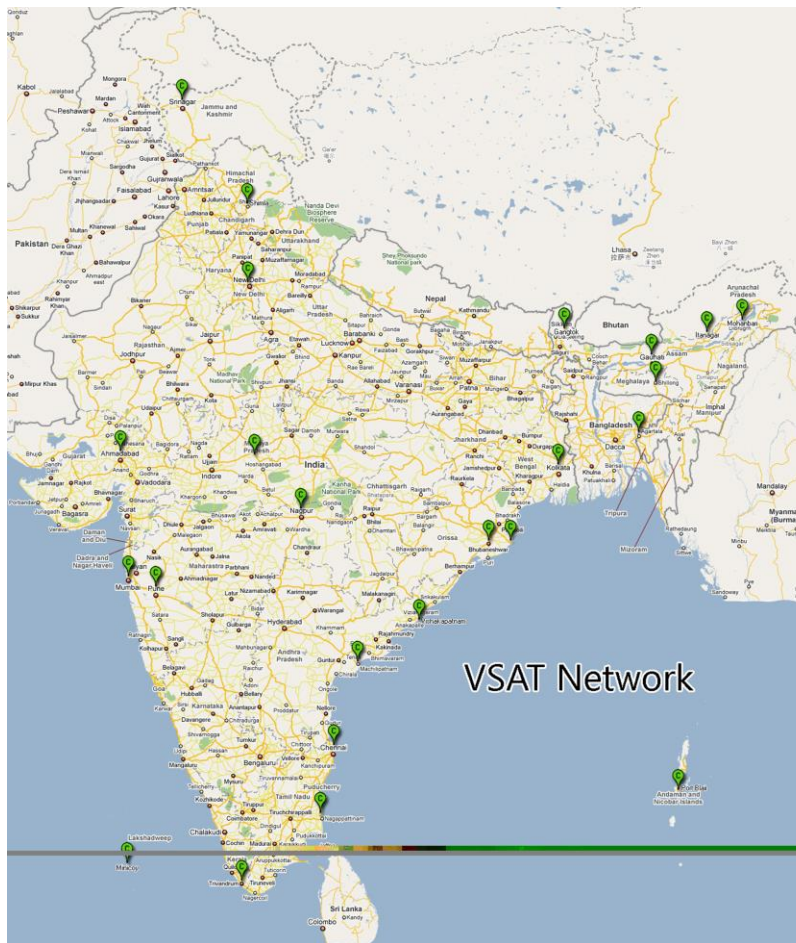

Features:

- All the VSATs are interconnected with each other as well as RTH, New Delhi.
- The VSAT system connected to the PC through the Ethernet port.
- All the VSAT systems have internet access.
- Standard internet software packages such as Email, FTP and Web used to connect remote nodes of VSAT, AMSS, HQ etc.

9. National Climate Data Centre (NCDC)

The Office of Additional Director General of Meteorology (Research) of India Meteorological Department (IMD), Pune, is a research and climatological division under which National Climate Data Centre (NCDC) functions as the custodian of all meteorological data that are meticulously processed and archived. NCDC preserves quality controlled long climate data and supplies for Weather Prediction, Aviation, Agriculture sectors, Environmental studies, Oceanography and Shipping and Researchers of various Institutions and Universities. The centre manages both real-time data such as Automatic Weather Stations (AWS) and non-real time data. With augmentations and expansions in the observational networks and observations, a modern Data Centre becomes a vital component

10. CLISYS

Functions of Clisys:

- Collect and safely store all climate data (historic as well as real time data).
- Allow an extensive management of metadata making climate database richer and more accurate.
- Ensure an efficient quality control of data to make sure data series are precise and relevant.
- Provide a flexible and scalable production system in order to add value to raw data and be able to deliver standard climatological reports and statistics, as well as customized products (graphs, charts, maps, etc.) especially elaborated to fulfill the needs of a specific end-user.
- Enable easy access to data and share heritage worldwide according to data policy and WIS recommendations.

Features of Clisys System:

- A web-based architecture: through a simple internet browser, user-friendly interfaces and user rights policy, Clisys offers an easy and instantaneous access to data management, product elaboration or system administration.
- A unified data storage structure: all your data and metadata are stored in one unique powerful database ensuring thereby the centralization and the uniqueness of all information.
- A reliable monitoring system: Clisys provides you with maps and reports concerning the condition of your observation network.
- A flexible and open data import system: Clisys is able to ingest all types of climate data. Whether they are historical, coming in real-time from automatic weather stations or from Global Telecommunication System, they will be easily acquired and stored by the system.
- Highly efficient quality control mechanisms: are your data exact? Should some figures be tagged as outliers and should they be corrected? The value of your climate database lies in its accuracy. This is why Clisys runs control quality tests all along the process, from data ingestion to storage. Of course, the system keeps track of all modifications brought to your data.
- A full compliance with WMO practices and recommendations: Clisys was evaluated by WMO and declared fully compliant. It is listed on the WMO website as one of the leading CDMS on the market.

11. Public Weather System (PWS):

Functions:

- A web-based architecture and a user-friendly interface: MeteoFactory® is a turnkey solution, easily accessible and functioning on a single web interface with rights management for all parties involved in the PWS process.
- A unique product design toolbox: MeteoFactory® comes with a set of default templates created by professional graphic designers (fax, ready-to-print press formats, extranet...) but it also allows extensive product creation or customization.
- A powerful production center and dissemination system that automatically generates finalized and high-quality products for all modern communication media (email, FTP, SMS, website, video...). The system is also equipped with an automatic scheduling server that delivers up-to-date information to subscribed end-users.
- An integrated Early Warning Solution for the generation and the dissemination of weather alerts and warnings maps, fully compliant with WMO recommendations for meteorological and hydrological alerts (MHEWS). MeteoFactory® also includes a cyclone module.

12. Video wall



A video wall in television studio

A video wall is a special multi-monitor setup that consists of multiple computer monitors, video projectors, or television sets tiled together contiguously or overlapped in order to form one large screen. Screens specifically designed for use in video walls usually have narrow bezels in order to minimize the gap between active display areas, and are built with long-term serviceability in mind. Such screens often contain the hardware necessary to stack similar screens together, along with connections to daisy chain power, video, and command signals between screens. A command signal may, for example, power all screens in the video wall on or off.

Reasons for using a video wall instead of a single large screen can include the ability to customize tile layouts, greater screen area per unit cost, and greater pixel density per unit cost,

due to the economics of manufacturing single screens which are unusual in shape, size, or resolution.

Simple video walls can be driven from multi-monitor video cards, however more complex arrangements may require specialized video processors, specifically designed to manage and drive large video walls. Software-based video wall technology that uses ordinary PCs, displays and networking equipment can also be used for video wall deployments.

Video wall controller

A video wall controller (sometimes called “processor”) is a device that splits a single image into parts to be displayed on individual screens. Video wall controllers can be divided into groups:

1. Hardware-based controllers.
2. Software-based PC & video-card controllers.

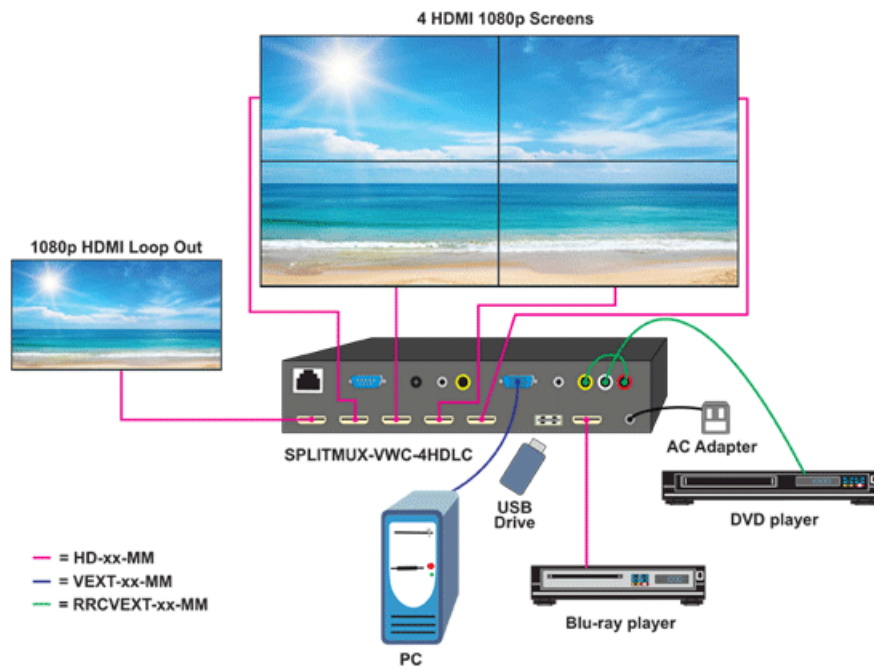

Hardware-based controllers are electronic devices built for specific purpose. They usually are built on array of video processing chipsets and do not have an operating system. The advantage of using a hardware video wall controller is high performance and reliability. Disadvantages include high cost and the lack of flexibility.

The most simple example of video wall controller is single input multiple outputs scaler. It accepts one video input and splits the image into parts corresponding to displays in the video wall.

Most of professional video wall displays also have built-in controller (sometimes called an integrated video matrix processor or splitter). This matrix splitter allows to “stretch” the image from a single video input across all the displays within the whole video wall (typically arranged

in a linear matrix, e.g., 2x2, 4x4, etc.). It is a fairly simple method to build a video wall but it has some disadvantages. First of all, it is impossible to use full pixel resolution of the video wall because the resolution cannot be bigger than the resolution of the input signal. It is also not possible to display multiple inputs at the same time.

Software-based PC & video-card controllers is a computer running an operating system (e.g., Windows, Linux, Mac) in a PC or server equipped with special multiple-output graphic cards and optionally with video capture input cards. Though this approach is typically more expensive, the advantage of a software-based video wall controller vs the hardware splitter is that it can launch applications like maps, VoIP client (to display IP cameras), Supervisory Control And Data Acquisition (SCADA) clients, Digital Signage software that can directly utilize the full resolution of the video wall. That is why software-based controllers are widely used in control rooms and high-end Digital Signage. The performance of the software controller depends on both the quality of graphic cards and management software.

13. Video conferencing

Video conferencing is live, visual connection between two or more remote parties over the internet that simulates a face-to-face meeting. Video conferencing is important because it joins people who would not normally be able to form a face-to-face connection.

At its simplest, video conferencing provides transmission of static images and text between two locations. At its most sophisticated, it provides transmission of full-motion video images and high-quality audio between multiple locations.

How video conferencing works:

The video conferencing process can be split into two steps: compression and transfer.

During compression, the webcam and microphone capture analog audiovisual (AV) input. The data collected is in the form of continuous waves of frequencies and amplitudes. These represent the captured sounds, colors, brightness, depth and shades. In order for this data to be transferred over a normal network -- instead of requiring a network with massive bandwidth -- codecs must be used to compress the data into digital packets. This enables the captured AV input to travel faster over broadband or Wi-Fi internet.

During the transfer phase, the digitally compressed data is sent over the digital network to the receiving computer. Once it reaches the endpoint, the codecs decompress the data. The codecs

convert it back into analog audio and video. This enables the receiving screen and speakers to correctly view and hear the AV data.

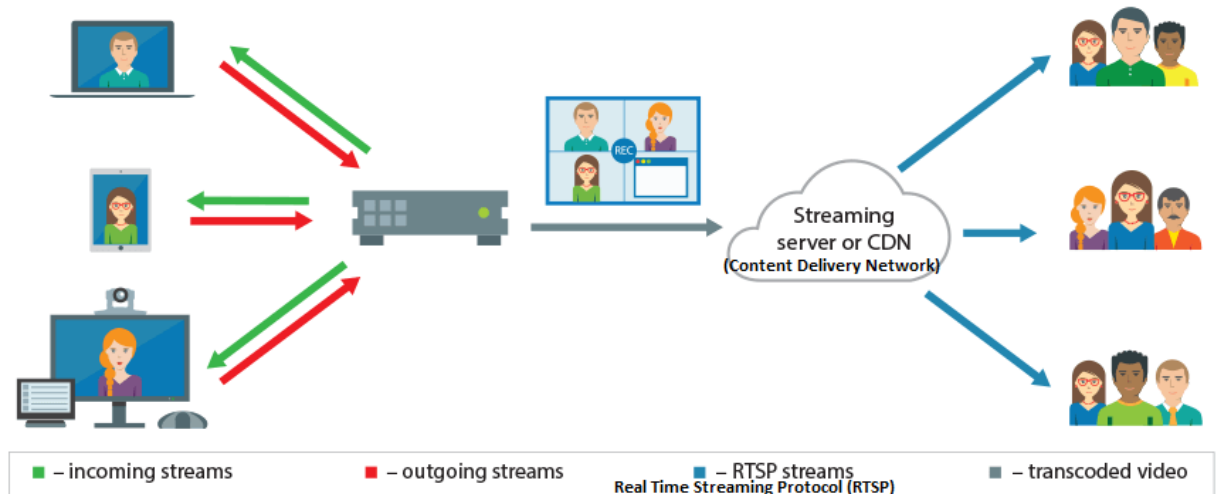

Components of video conferencing systems:

The components of a video conferencing system include the following:

- A network for data transfer. This is usually a high-speed broadband internet connection, which uses similar technology as voice over Internet Protocol (VoIP). Local area network (LAN) and Integrated Services Digital Network (ISDN) connections are occasionally used as well.
- Two or more video cameras or webcams that provide video input.
- Two or more microphones -- either an external microphone or one built into the accessing device.
- A computer screen, monitor, TV or projector that can broadcast video output.
- Headphones, laptop speakers or external speakers that can be used for audio output.
- Hardware- or software-based coding and decoding technology, called codecs. These can compress AV data into digital packets on the distributing end and then decompress the data at the endpoint. Codecs reduce the amount of bandwidth needed.

- Acoustic echo cancellation (AEC) software, which reduces audio delays and supports real-time communication.